



Innovation in Science Education

Case of the “Small Science” Curriculum

TWAS Regional Prize, 2011 for the
development of scientific educational material

November 16, 2012, JNCASR, Bangalore
Modified: April 4, 2013, HBCSE, Mumbai

Jayashree Ramadas

Homi Bhabha Centre for Science Education
Tata Institute of Fundamental Research

Homi Bhabha Centre for Science Education

HBCSE's goal is to bring about a positive change in science and maths education from primary school to undergraduate level in the country; to influence students, teachers and policy, and to build expertise, resources and opinion that are conducive to good education at all levels. HBCSE's work is premised on a close interaction between research, development of materials, and sustained outreach programs with teachers and students.

HMB Minutes, March 21, 2012

Homi Bhabha Centre for Science Education

Our Aim

- To improve the quality of science and mathematics education in the country from primary school up to undergraduate level



Specifically we aim to:

- Generate new ideas
- Translate them to useable forms
- Demonstrate or implement the ideas on a small or large scale

Research and Innovation

Development of materials and methods

Outreach and Advocacy

Knowledge-base for Innovation

1. Research in Science Education

- Cognitive studies
- Socio-cultural studies

2. Practice of Science / Science Education

-
-

Research areas at HBCSE

Students' conceptions

Design and technology

Out-of-school learning

Mathematical understanding

Learner-centred practices,
collaboration, diversity

Concept mapping

Socio-scientific, ethical,
moral issues

Concept Inventories

Affective outcomes,
student engagement

Model-based reasoning

Testing and assessment

Visuo-spatial and embodied
modes of reasoning

Knowledge-base for Innovation

2. Practice of Science Education

- Learning, teaching, interviewing
- Observations of schools and lessons - rural, urban, formal and non-formal ~ 200 hours
- Teacher education
- Classroom trials

Process of curriculum development

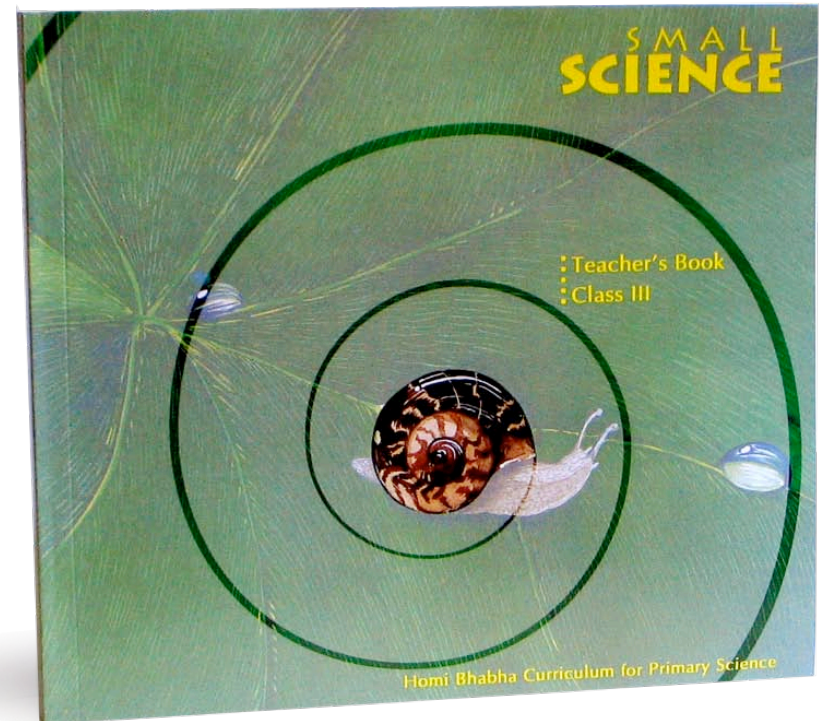
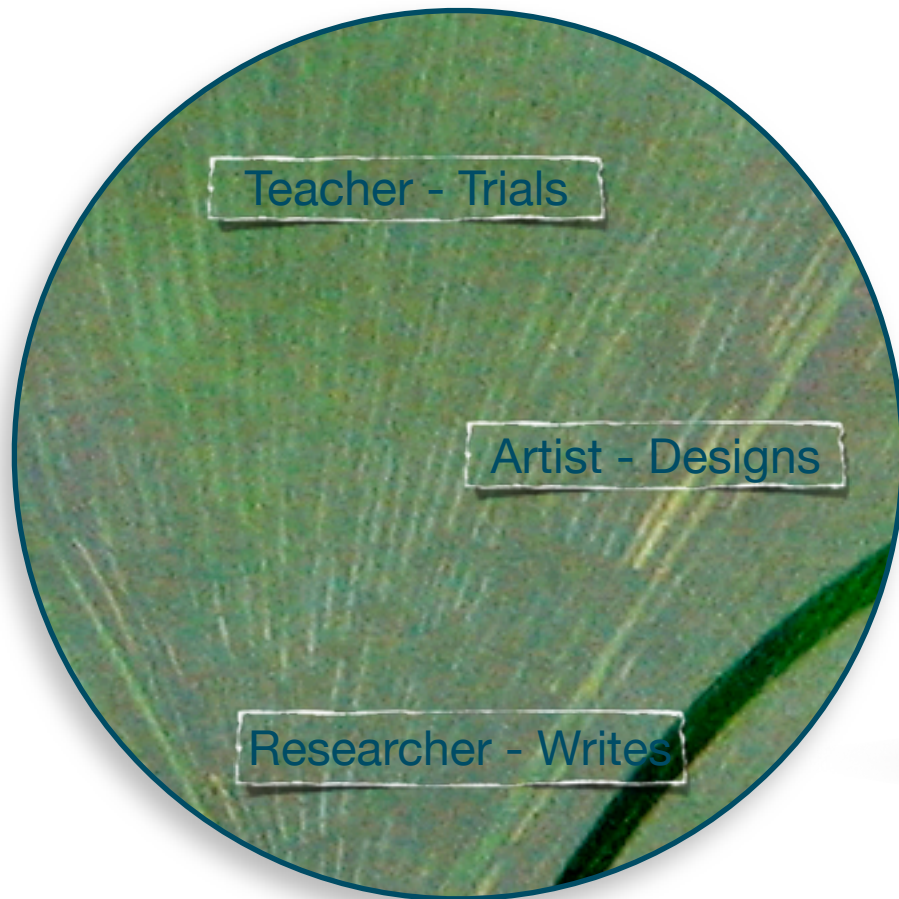

<http://www.hbcse.tifr.res.in/smallscience>

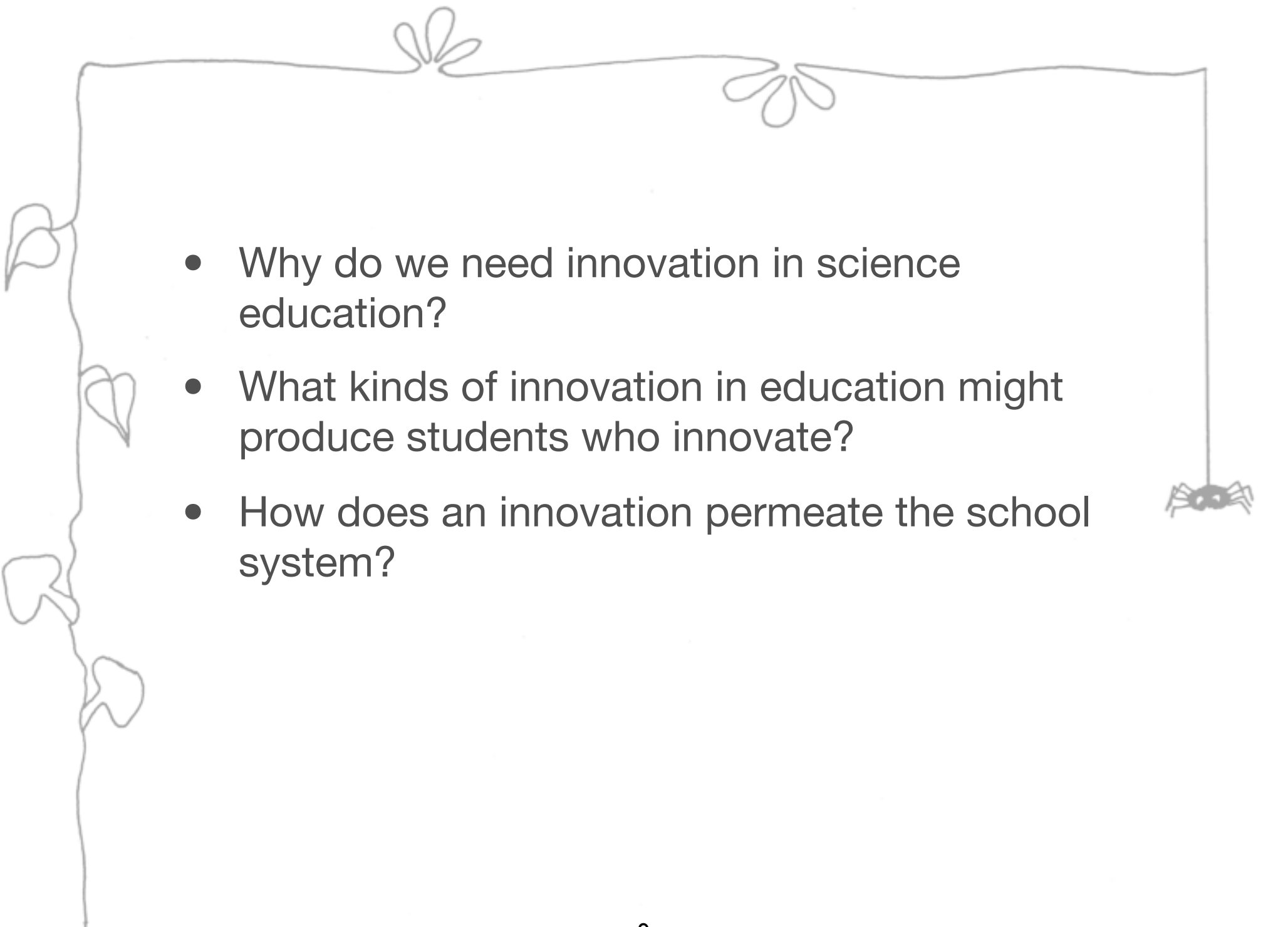
- 
- A decorative border surrounds the text. It features a wavy top line with two floral motifs. The left side has a vertical line with several heart-shaped leaf-like motifs. The right side has a vertical line ending in a small spider illustration.
- Why do we need innovation in science education?
 - What kinds of innovation in education might produce students who innovate?
 - How does an innovation permeate the school system?



State of school science education

“(Our) teaching methods are mercilessly stultifying, and it is a miracle that children survive them without entirely losing their creative abilities and independence of mind.”

- *Public Report on Basic Education (PROBE) in India (1999)*

Rural Students

- Rich experiences
- Lack systematisation and clear expression

Urban Students

- Bookish learning
- Ignore natural surroundings



The Small Science Approach

- Asking questions, making sense of the natural world
- Organised experiences enhance and enrich life experiences
- Experiences of the natural world
 - NOT a sanitised, idealised, prettified world
 - NOR a far-away, fantastic world (e.g. NatGeo Explorer)
 - But the world in which you live, which you engage with
- Authentic experiences
 - A decaying banana peel
 - The sky, sun, moon, stars





The Small Science Approach

- Engage with the world through observing, drawing, recording, analysing, expressing, discussing, arguing, writing ... communicating with peers
- Tools for learning and thinking:
 - Systematic observation
 - Counting, tabulating, graphing – Quantitative thinking
 - Expressing, describing, writing – Language skills
 - Planning, constructing – Design and engineering

Systematic observations

- Learning through inquiry

Try planting different dals, grains of rice, sago. Do they sprout? Make your own guess why they did not sprout?

3. Watch closely!

Which of the seeds sprouted first? Did you see the tiny root going into the soil? Which plants grew the tallest?



Systematic Observation

- Addressing student's conceptions

Students noticed that the bottle of cold drink got wet on the outside. A few minutes after they wiped the water off, the bottle was wet again!
... Most of the students said, “(it is wet) because it is cold.” ... Some thought that the water might come from the cold drink. Others disagreed. ... Their arguments:

“The water outside is not sticky like the cold drink.”

“There are no holes in the ice-cream cup; it does not leak.”

“If there is warm water in the bottle it does not come out. Why should cold water come out?”

Systematic Observation

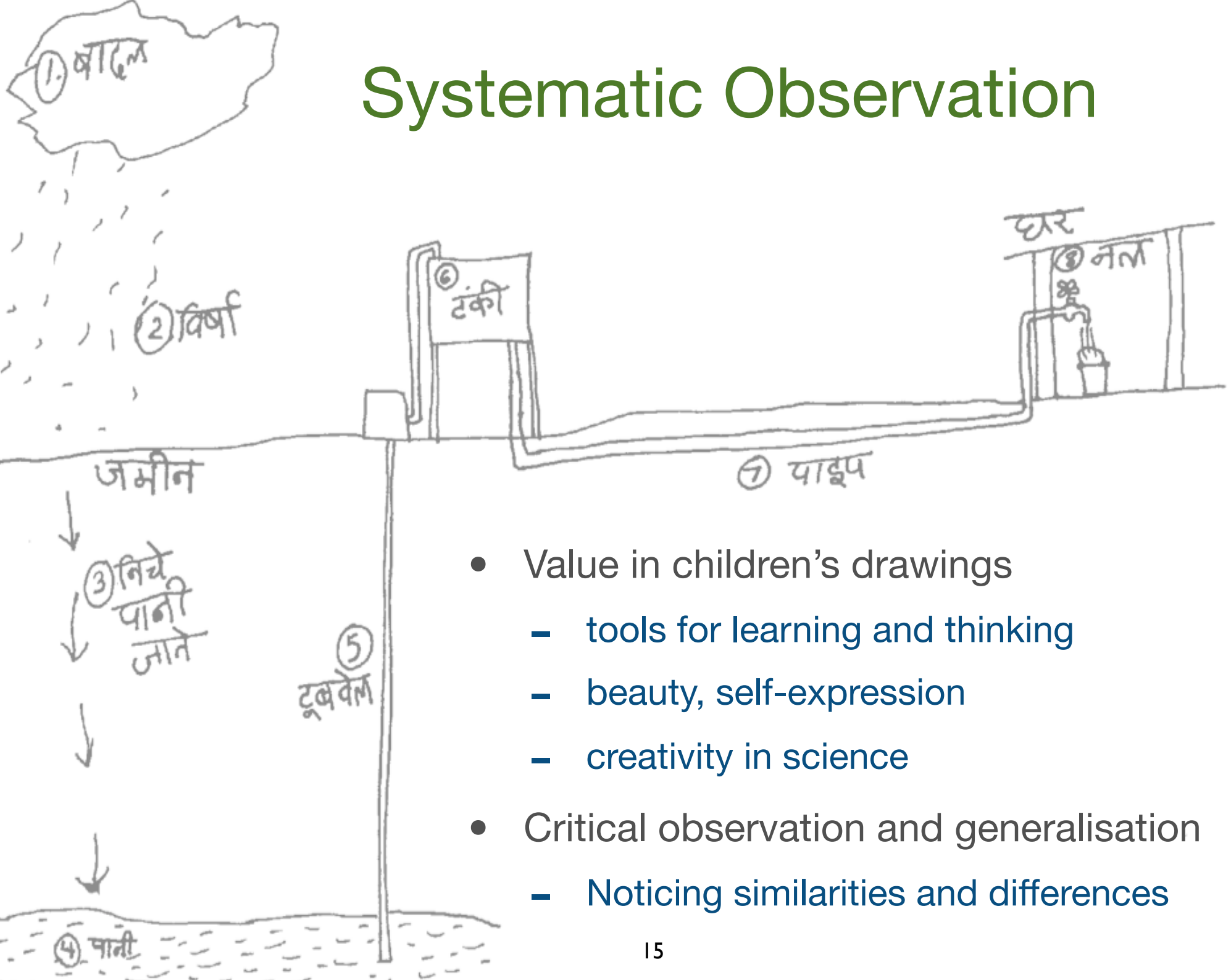

- Value in children's drawings
 - tools for learning and thinking
 - beauty, self-expression
 - creativity in science
- Critical observation and generalisation
 - Noticing similarities and differences

Observation and analysis

Write the name of each musical instrument underneath its picture:

bansuri ransingha guitar veena chimta santoor mridangam
 ghatam sitar mahudi shehnai sarangi clapper harmonica
 tanpura ektara tabla harmonium

Sort all these instruments into the groups shown in the diagram. Write each instrument's number in the right place. The first four have been done for you.

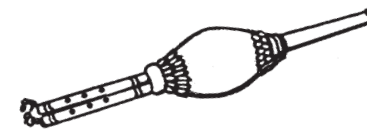
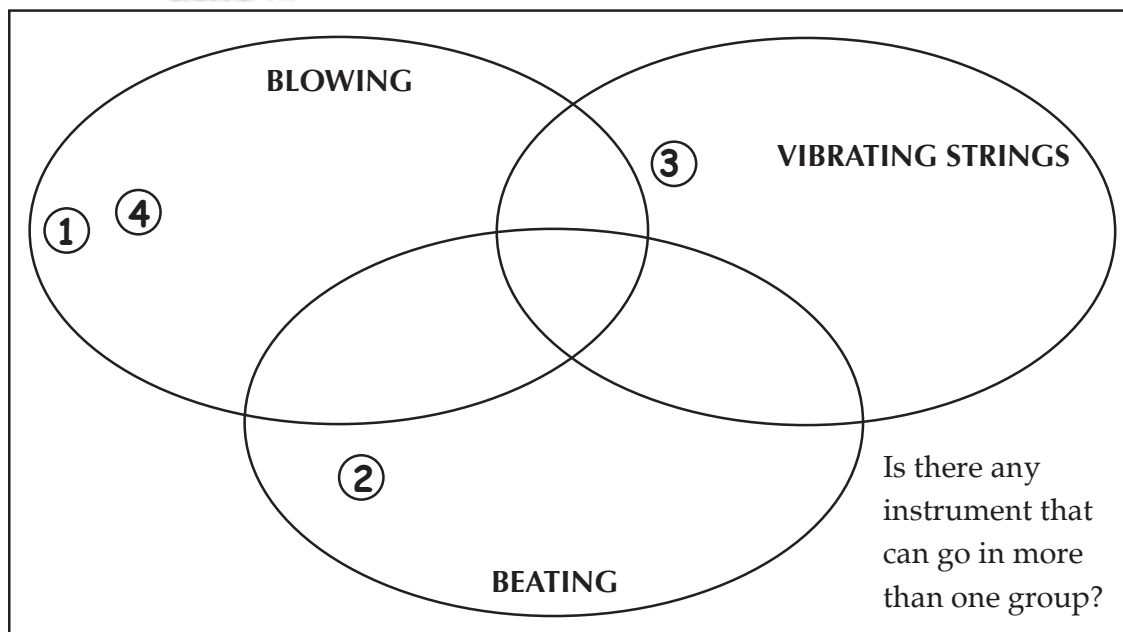

1

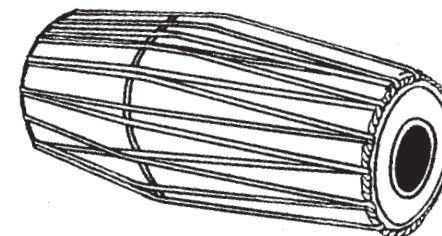

2

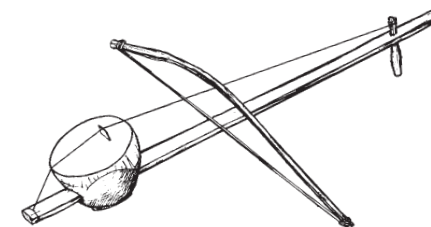

3

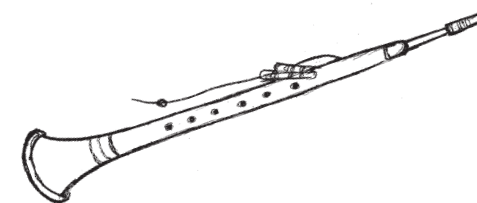

4

Observation and analysis

What's the same? What's different?

For each event listed below, put a tick if any of these polluting things are getting into the air.

Event	Poisonous gases	Dust	Smoke	Microbes
a. a bullock cart goes down a dusty road				
b. a truck goes down a dusty road				
c. a person spits				
d. a tree grows				

Quantitative thinking

- Watch for numbers
- Count, estimate
- Seriate
- Measure
- Shapes and sizes
- Picture graphs
- Venn diagrams

Count the number of plants and animals you see:

** in summer*

** when the rains begin*

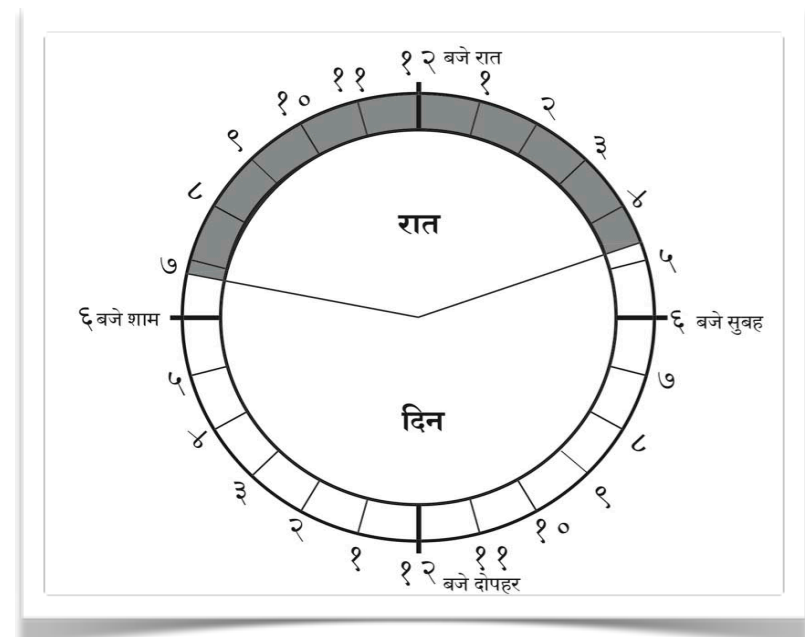

Language skills

*It bubbles, it blows
It creeps and it flows
It whistles, it sings
Lifts bird on their wings*

- Language for fun
 - Stories and poems
 - Word play

Think of some 'sound words' ...

*bang! Trrrning hum squeak plop
sshroookh*

Language skills

- Oral and written expression
 - Recounting experiences
 - Asking questions
 - Critical thinking, argument, debate

Talk and write

Think of the air you breathe every day. Is it clean or dirty? Why do you think so? What things make your air either dirty or clean? What can you do to get clean air?

Design & Engineering

- Planning, drawing, constructing

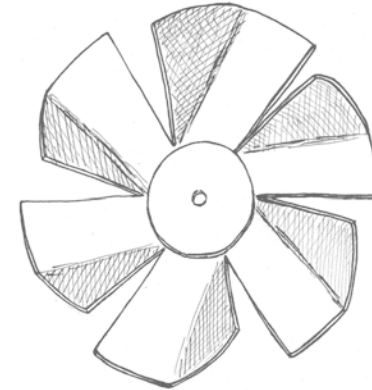
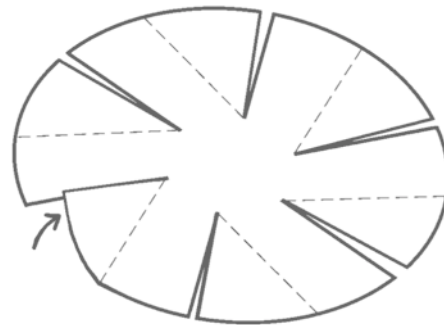
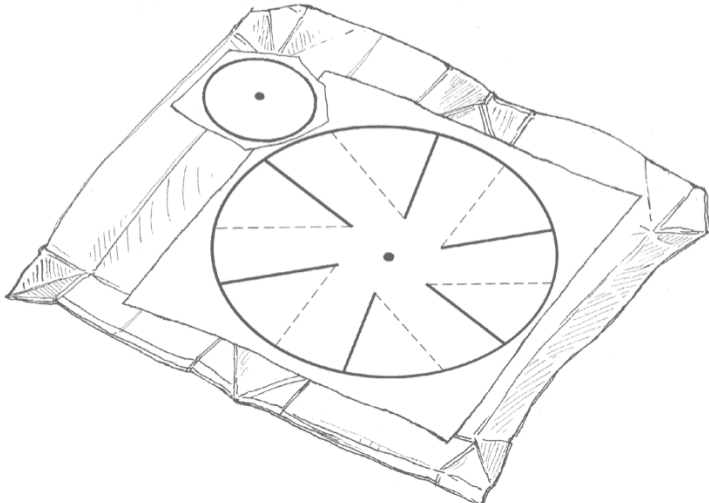
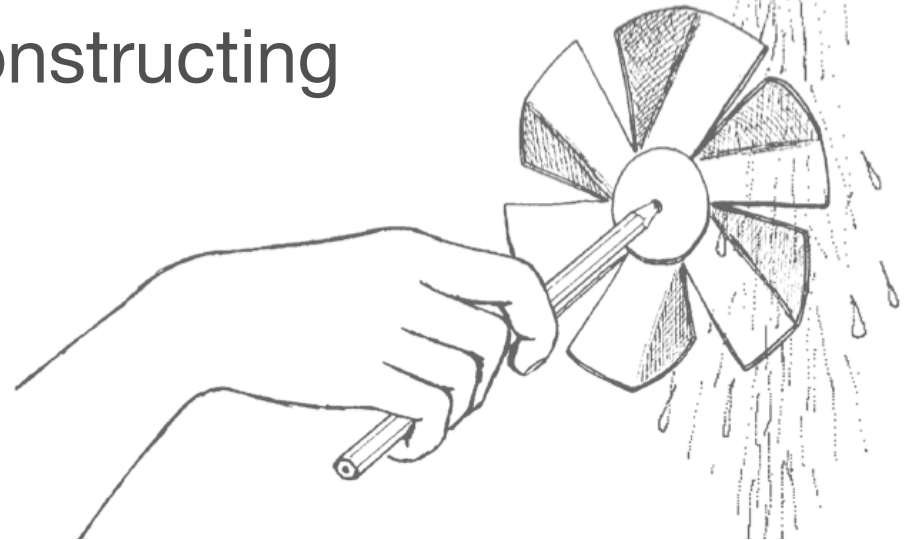
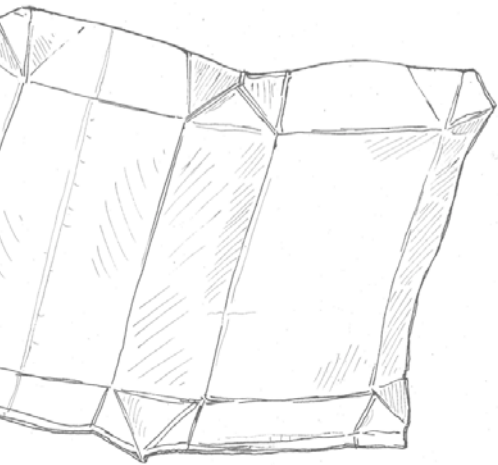

Values in Science Education

- Sensitivity to social issues
- Values conveyed implicitly
 - Caring for living things
 - Conserving resources
 - Community living, equity
 - Working with hands
 - Literary and aesthetic sensibilities
 - Feelings, emotions

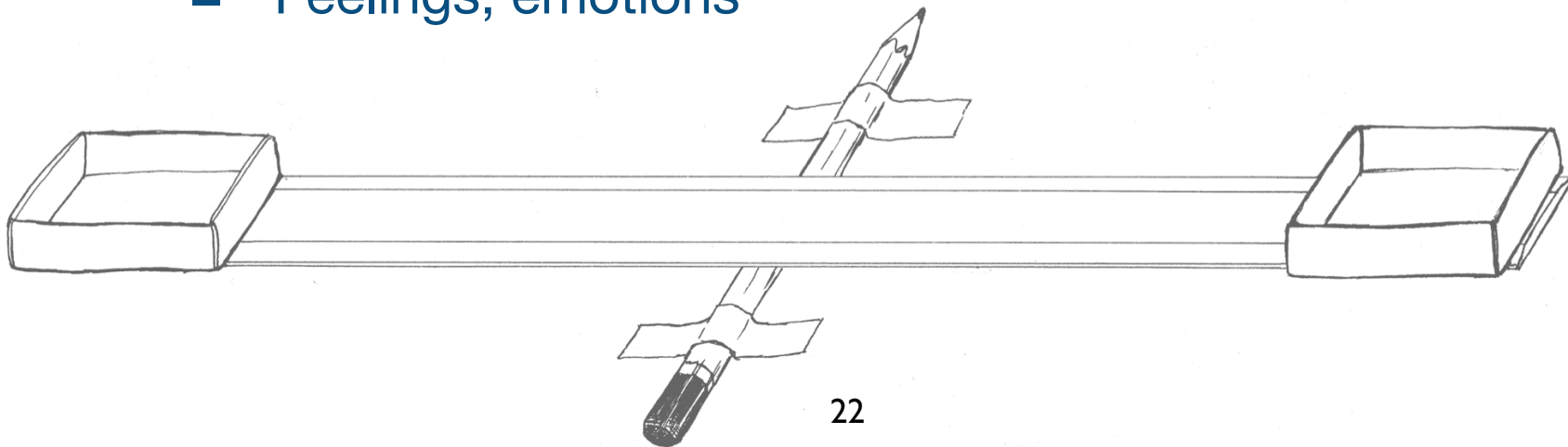



Small Science TextBook and Workbook (Classes 3-5)

- In English, Hindi, Marathi and Urdu
- Text Book
 - Interweaves a story about two curious children Mini and Apu, who learn by doing and asking questions
- Work Book
 - A format for recording
 - Used for continuous evaluation
 - Provides feedback to the student and parents

Small Science Teacher's Book (Classes 1-5)

- In English, Hindi & Marathi
 - First-person accounts
 - Summarises collective teaching experiences of field trials
 - Organised information enabling the teacher to
 - Anticipate student's responses
 - Keep students engaged
 - Handle wide-ranging classroom discussion
 - Invites teachers to add their own experiences



Small Science Curriculum Books

Small Science Books in English

- J. Ramadas, A. Kawalkar and S. Mathai : Small Science Class 1 and 2 Teacher's Book, Mumbai: Homi Bhabha Centre for Science Education, 2004.
- J. Ramadas: Small Science Class 3 TextBook, Mumbai: Homi Bhabha Centre for Science Education, 1998; New Delhi: Oxford University Press, 2007.
- J. Ramadas: Small Science Class 3 WorkBook, Mumbai: Homi Bhabha Centre for Science Education, 1998; New Delhi: Oxford University Press, 2007.
- J. Ramadas: Small Science Class 3 Teacher's Book, Mumbai: Homi Bhabha Centre for Science Education, 1998; New Delhi: Oxford University Press, 2007.
- J. Ramadas: Small Science Class 3: Teacher's Book CD, New Delhi: Oxford University Press, 2007.
- J. Ramadas: Small Science Class 4 TextBook, Mumbai: Homi Bhabha Centre for Science Education, 2001; New Delhi: Oxford University Press, 2007.
- J. Ramadas: Small Science Class 4 WorkBook, Mumbai: Homi Bhabha Centre for Science Education, 2001; New Delhi: Oxford University Press, 2007.
- J. Ramadas: Small Science Class 4 Teacher's Book, Mumbai: Homi Bhabha Centre for Science Education, 2001; New Delhi: Oxford University Press, 2007.
- J. Ramadas: Small Science Class 4: Teacher's Book CD, New Delhi: Oxford University Press, 2007.
- J. Vijapurkar: Small Science Class 5 TextBook, Mumbai: Homi Bhabha Centre for Science Education, 2003; New Delhi: Oxford University Press, 2007.
- J. Vijapurkar: Small Science Class 5 WorkBook, Mumbai: Homi Bhabha Centre for Science Education, 2003; New Delhi: Oxford University Press, 2007.
- J. Vijapurkar: Small Science Class 5 Teacher's Book, Mumbai: Homi Bhabha Centre for Science Education, 2006; New Delhi: Oxford University Press, 2007.
- J. Vijapurkar: Small Science Class 5 Teacher's Book CD, New Delhi: Oxford University Press, 2007.

Small Science Books in Hindi

- J. Ramadas (Tr. K. K. Mishra): हलका फुलका विज्ञान पाठ्य-पुस्तिका कक्षा ३, Mumbai: Mumbai: Homi Bhabha Centre for Science Education, 1999.
- J. Ramadas (Tr. K. K. Mishra): हलका फुलका विज्ञान कार्य-पुस्तिका कक्षा ३, Mumbai: Homi Bhabha Centre for Science Education, 1999.
- J. Ramadas (Tr. K. K. Mishra): हलका फुलका विज्ञान शिक्षक-पुस्तिका कक्षा ३, Mumbai: Homi Bhabha Centre for Science Education, 2000.
- J. Ramadas (Tr. K. K. Mishra): हलका फुलका विज्ञान पाठ्य-पुस्तिका कक्षा ४, Mumbai: Homi Bhabha Centre for Science Education, 2002.
- J. Ramadas (Tr. K. K. Mishra): हलका फुलका विज्ञान कार्य-पुस्तिका कक्षा ४, Mumbai: Homi Bhabha Centre for Science Education, 2002.
- J. Ramadas (Tr. K. K. Mishra): हलका फुलका विज्ञान शिक्षक-पुस्तिका कक्षा ४, Mumbai: Homi Bhabha Centre for Science Education, 2007.

Small Science Books in Marathi

- J. Ramadas, A. Kawalkar and S. Mathai (Tr. Deepali Palshikar) : हलके फुलके विज्ञान शिक्षक पुस्तक इयत्ता १ ली व २ री, Mumbai: Homi Bhabha Centre for Science Education, 2010.
- J. Ramadas (Tr. Shivali Tukdeo): हलके फुलके विज्ञान पाठ्यपुस्तक इयत्ता तिसरी, Mumbai: Homi Bhabha Centre for Science Education, 2000.
- J. Ramadas (Tr. Shivali Tukdeo): हलके फुलके विज्ञान कृती पुस्तक इयत्ता तिसरी, Mumbai: Homi Bhabha Centre for Science Education, 2000.
- J. Ramadas (Tr. Shivali Tukdeo): हलके फुलके विज्ञान शिक्षक पुस्तक इयत्ता तिसरी, Mumbai: Homi Bhabha Centre for Science Education, 2000.
- J. Ramadas (Tr. Deepali Palshikar): हलके फुलके विज्ञान पाठ्यपुस्तक इयत्ता चौथी, Mumbai: Homi Bhabha Centre for Science Education, 2003.
- J. Ramadas (Tr. Deepali Palshikar): हलके फुलके विज्ञान कृती पुस्तक इयत्ता चौथी, Mumbai: Homi Bhabha Centre for Science Education, 2003.
- J. Ramadas (Tr. Deepali Palshikar and Shobhana Bhide): हलके फुलके विज्ञान शिक्षक पुस्तक इयत्ता चौथी, Mumbai: Homi Bhabha Centre for Science Education, 2006.

Small Science Books in Urdu

Urdu translations of the students' books for Classes 3 and 4 are published by the Centre for Promotion of Science, Aligarh Muslim University, Aligarh 202 002, U.P., India.

- J. Ramadas (Tr. Nihal Saghar, Ed. Noman Ghani): ہلکی پھلکی سائنس : عملی کتاب درجہ تیسری, Aligarh: Centre for Promotion of Science, Aligarh Muslim University, 2008.
- J. Ramadas (Tr. Wadoodul Haque Siddiqui, Ed. S.M.A. Hashim Rizvi): ہلکی پھلکی سائنس : درسی کتاب درجہ چار, Aligarh: Centre for Promotion of Science, Aligarh Muslim University, 2008.
- J. Ramadas (Tr. Wadoodul Haque Siddiqui, Ed. S.M.A. Hashim Rizvi): ہلکی پھلکی سائنس : عملی کتاب درجہ چار, Aligarh: Centre for Promotion of Science, Aligarh Muslim University, 2008.

Comments from a teacher

“The children just loved the books so much that for the first few weeks throughout the school these books were in their hands, irrespective of whatever was being taught. The pictures, experiments and activities just touched them.

...

This year witnessed remarkable growth in EVERY SINGLE CHILD, in many aspects - including confidence, experimentation capabilities, observational skills, scientific temper, self reliance and co-operation, team building, sharing, criticizing, and a few kids have even shown signs of hypothesizing”

- *Gunvant Jain, Teach for India, from a Pune Municipal School (2011)*

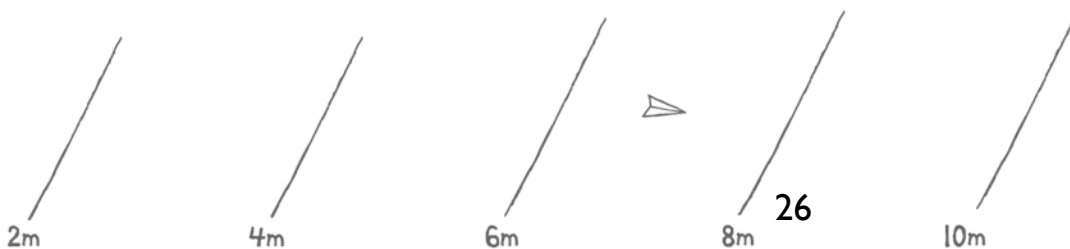

Comments from a student



“Small Science was the first book that was compelling to me. It didn't just have a to-the-point chunk of text with a few illustrations instead, it had poetry, recipes, tips, amusing stories. All this was designed to engage and stir the curiosity of a child. It was a breath of fresh air. The books opened my eyes to a whole new way of learning - one I wish was implemented across all schools.”

- Ramya Mohan, college student (2012), recalls from her school days

From idealisation to realisation

"Classroom materials in the form of innovative curricula are clearly not enough to achieve a meaningful change in science education. To ensure that classroom transactions move beyond the levels of naive enthusiasm to purposeful conviction, programmes for the professional development of teachers is a primary concern which requires serious attention from developers of innovative curricula as well as the schools that choose to adopt them."

- Choksi, B. (2007) *Evaluating the Homi Bhabha Curriculum for Primary Science: In Situ. Technical Report No. 1 (07-08), October 2007, 31+17 pp.*

"The classroom observations and the teachers responses to the orientation workshop point to ...: the need for improving teachers' subject knowledge ... (and) the need for a shift in teachers understanding of the nature of science as well as of science teaching."

- Raveendran, A., (2009) *Implementation of Small Science in a Mumbai School: Deriving Implications for Teacher Development, Internal Report, HBCSE, Mumbai, May, 2009, 12+10 pp*



How does an innovation permeate the school system?

- Schools in India: Space for innovative curricula?
 - Government (5.20 L) ~50%
 - (State Government, Central Government, Public Sector Undertaking or an Autonomous Organization completely financed by the Government)
 - Local Body (2.92 L) ~28%
 - (Panchayati Raj, Zilla Parishad, Municipal Corporation/Committee, Notified Area Committee and Cantonment Board)
 - Private aided (0.81 L) ~8%
 - (Individual/private organization, receives grant from government or local body)
 - Private unaided (1.36 L) ~13%
 - (Individual/private organization, does not receive grant from government or local body)
 - Ashram School (10.1 K) ~1%
 - (Residential schools to provide functional and liberal education to tribal boys and girls on the pattern of Gurukuls with free boarding and lodging facilities)

Source: Seventh all India School Education Survey, NCERT, 2006

http://www.ncert.nic.in/programmes/education_survey/pdfs/Schools_Physical_Ancillary_Facilities.pdf

How does an innovation permeate the school system?

- **1998-99**
 - Request for Government permission from Aga Khan Society and *Srujan Anand*, Kolhapur
 - Review by Government of Maharashtra: Director of Education, SCERT, *Balbharati*, SISE, Education Secretary
 - DPEP? UNICEF subsidy for experimental edition?
 - White Paper on Education (1972) was cited.
- **2002-03**
 - Science Textbooks of Ladakh (SECMOL) used parts
 - Delhi SCERT considered adoption; used parts
 - Andhra SCERT (2012, to be seen)
- Sales 1000 copies/book/year; broad range of schools

How does an innovation permeate the school system?

- Publication under Creative Commons
 - Who will print?
 - Who will distribute?
 - Access for primary school students and teachers?
- The dilemma of private publication
 - Exclusive rights
 - Governments are deterred
- A worthy cause for public-private partnership

How does an innovation permeate the school system?

- **2005** NCERT considered publication and distribution
 - Textbook policy committee
 - Alternative textbooks possible
 - But logistical load
 - Science and social studies integration
- **2007-12** Oxford University Press
- **2012-** InOpen Technologies SINE, IIT-Bombay
Society for Innovation and Entrepreneurship
- All books are downloadable from HBCSE website

How does an innovation permeate the school system?

National Curriculum Framework NCF 2005

- For the first time, a large number of university based academics and professionals from across disciplines have contributed
- Often without an official or institutional mandate
- On teaching of science: contributions from HBCSE and Eklavya

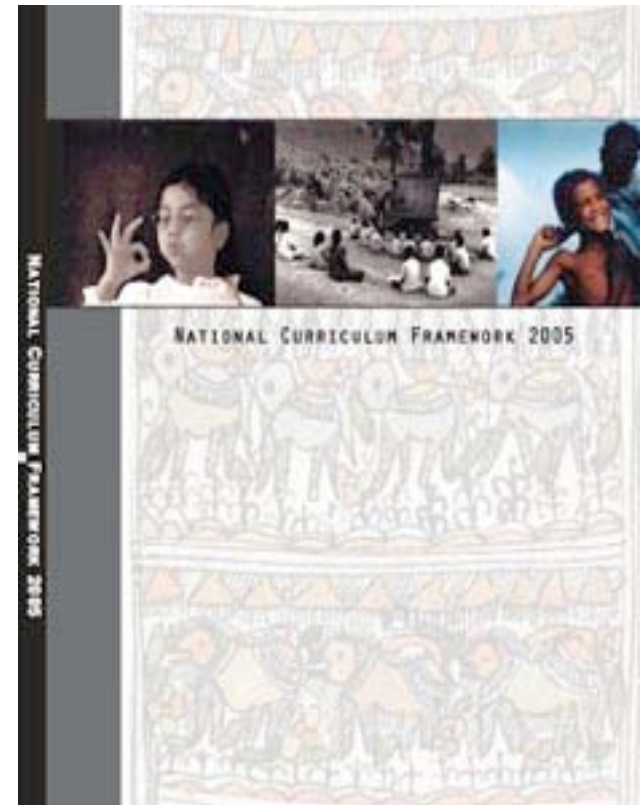

The power of ideas: From Small Science to the National Curriculum Framework, 2005

What biology do students know?

...

Janabai lives in a small hamlet in the Sahyadri hills. She helps her parents in their seasonal work of rice and tuar farming. She sometimes accompanies her brother in taking the goats to graze in the bush. She has helped in bringing up her younger sister. Nowadays she walks 8 km. every day to attend the nearest secondary school. ...

Validities of the curriculum:

1. Cognitive validity requires that the content, process, language and pedagogical practices of the curriculum are age appropriate, and within the cognitive reach of the child.
2. Content validity requires that the curriculum must convey significant and correct scientific information. Simplification of content, which is

C. Natarajan, S. Chunawala, S. Apte and J. Ramadas: Students' Ideas about Plants, Diagnosing Learning in Primary Science (DLIPS) Part-2, Technical Report No. 30, Homi Bhabha Centre For Science Education, Mumbai, 1996.

Language for and through Science

Asking questions

"Air is everywhere" is a statement that every schoolchild learns. Students may know that the earth's atmosphere consists of several gases, or that there is no air on the moon. We might be happy that they know some science. But consider this exchange in a Class IV classroom.

J. Ramadas: Small Science Class 4 (Teacher's Book), Homi Bhabha Centre for Science Education, Mumbai, 2001, pp. 114-115.

J. Ramadas: A framework abstracted from Small Science, Presented at the International Workshop on the History and Philosophy of Science: Implications for Science Education, HBCSE, Mumbai, February 22-26, 1999.

How does an innovation permeate the school system?

- Teacher support
 - Teacher's Books
 - Website Resources
 - Mailing List
 - Integrated Media
 - Orientation and school visits
- Parental acceptance

How does an innovation permeate the school system?

More synergies

- Implementing schools
- InOpen
 - www.inopen.in
- Arvind Gupta Toys
 - www.arvindguptatoys.com
- Eklavya Kits
 - www.eklavya.in

Implementing schools



Gram-mangal school, Vikramgad



A. K. Joshi School, Mumbai

Al Qamar Academy, Chennai

and many more...



An institutional effort

- Centre Director, HBCSE (1994-2008)
General Co-ordinator, Homi Bhabha Curriculum
 - Arvind Kumar
- Writing
 - Jayashree Ramadas (Classes 1&2, 3 & 4), Jyotsna Vijapurkar (Class 5), Aisha Kawalkar, Sindhu Mathai (Classes 1&2)
- Research Assistance
 - Pranita Gopal (Classes 1&2), Ritu Saxena (Class 3), Suchitra Varde (Class 4), Gouri Patil (Class 5)
- Design and Illustrations
 - Poornima Burte (Class 3) and first design, Karen Haydock (Class 4), Madhugandha Damle (Class 5), Archana Shinde (Classes 1 & 2), Sujata Deshpande (poster & presentations)
- Translations
 - हलका फुलका विज्ञान (Hindi): Krishna Kumar Mishra (Classes 3, 4)
हलका फुलका विज्ञान (Marathi): Deepa Palshikar and Shobhana Bhide (Classes 1&2, 4, 5), Shivali Tukdev (Class 3)
ہلکی فلکی سائنس (Urdu) Centre for Promotion of Science, Aligarh Muslim University : Nihal Saghar, Ed. Noman Ghani (Class 3), Wadoodul Haque Siddique, Ed. Hashim Rizvi (Class 4), M. K. Gupta



An institutional effort

- Website, computer support, presentations
 - Manoj Nair, Shubhada Manole
- Evaluation Studies
 - Beena Choksi (2007), Aswathy Raveendran (2009)
- Web Resources
 - Manish Chand, Anuja Farkade, Karen Haydock, Aisha Kawalkar, Vinisha K., Kumar Arunachal, Jyoti Kumbhare, Ankita Patel, Jayashree Ramadas, Aswathy Raveendran, Jyotsna Vijapurkar
- Collaborators in prior research
 - Swapna Apte (Narvekar), Joan Bliss, Nandini Bondale, Sugra Chunawala, B. B. Deshmane, Rosalind Driver, V. G. Kulkarni, Kala Laxminarayan, Usha Nair, Chitra Natarajan, S. P. Ozarkar, Michael Shayer
- School Feedback
 - A. K. Joshi English Medium School: Mrs. Goregaonkar; Al Qamar Academy, Chennai: Aneesa Jamal; Gram Mangal, Aine, Thane: Nilesh & Meena Nimkar; Lt. Shantabai Ladkat English Medium School, Pune: Gunvant Jain, Teach for India Fellow, 2010; Rishikul Vidyalaya:; Vivek High School, Chandigarh: Karen Haydock



Thank you

<http://www.hbcse.tifr.res.in/smallscience>